



SILVERLINE



iPod | Internet Radio | Satellite

for selected BMW/Mini Cooper vehicles

Installation Guide/User manual

Made for



iPod



iPhone

Copyrights and Trademarks

Copyright 2011 DICE Electronics, LLC.

The DICE Electronics logo is a trademark of DICE Electronics, LLC.

iPod is trademark of Apple, Inc.

Livio and Livio Car Internet Radio are registered trademarks of Livio Radio.

All rights reserved.

Printed in the U.S.A.

Table of Contents

Warning and safety	4	Controlling the DUO iPod source	23
Product registration	5	Controlling the DUO SIRIUS source	24
Silverline DUO kit contents.....	6	The Livio Car Internet Radio app	25
DIP switch overview	7	Data connection requirements	25
DIP switch settings for BMW/Mini	8	Controlling the Livio Car Internet Radio app	26
Supported iPod models	9	Text display from the Livio Car Internet Radio app	27
Note to Installer	10	Terminating the Livio Car Internet Radio app	28
Connection diagram	11	Optional Remote Kit: iPod/Livio	29
Connection diagram for DSP option	12	Optional Remote Kit: SIRIUS	30
Factory CD changer cable locations	13	Troubleshooting	31
Installation	14	Firmware update	34
iPod content heirarchy	17	Disclaimer & warranty	35
Charging	17		
iPod locked/unlocked settings and features	18		
Basic operation	19		
Controlling the DUO from select radios	20		

Warning and safety!

Please read these instructions carefully before proceeding. Failure to follow instructions may result in improper operation or injury. Neither DICE Electronics, LLC. nor Apple Inc., its regional offices, distributors or resellers take any responsibility for any damage or injury as a result of using the integration kit.

- Do not open, disassemble or alter the interface in any way.
- Do not insert anything into the casing.
- Do not cut or try to alter cables in any way and always use the correct connections.
- Only operate unit when stationary or ask passengers to operate it for you.
- Do not allow the Apple iPod to distract you from driving.
- Exercise good judgement and keep your eyes on the road at all times.
- Do not expose unit to extreme temperatures, humidity or shock.
- Keep the unit and iPod away from fluids.
- Keep away from children! - Interface components may contain small parts, can be broken or disassembled and components may become loose from vibration and heat. Small components and packaging materials may be a choking hazard when handled by children.



Congratulations on your purchase!

Thank you for purchasing the DICE Silverline DUO Integration Kit. Please review our user manual and installation guide before operating or installing the unit. This interface was designed and manufactured to seamlessly integrate with your vehicle's factory entertainment system.

Product registration

We recommend registering your DICE product so you can receive news about important firmware updates and have unlimited access to our online support system.

To register your DICE product, please complete the following steps:

1. Visit <http://www.register.diceelectronics.com>
2. Look up and save the serial number of the product.
3. Complete the product registration form.
4. Submit the form.
5. Save the registration/support/warranty sheet in a safe place for future reference.

If you are unable to complete the registration via internet, please call DICE Electronics at 1-888-342-3999.

Silverline DUO kit contents



Silverline DUO module



user manual

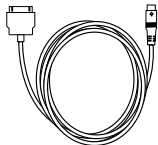

iPod docking cable

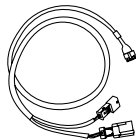

BMW Interface Harness

Optional accessories (sold separately):



AUX connector

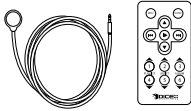

IR Receiver &
Remote controller

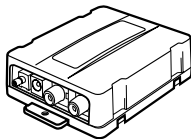

DICE DSP Kit
(ACC-BMW-DSP)

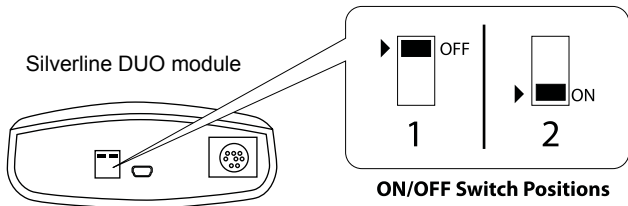

DIP switches

The configuration switches located on the Silverline DUO module are used to set various operation modes of the interface. Incorrect DIP switch settings may cause the DICE interface to not work properly or to not operate at all. **Disconnect the vehicle harness from the module and set the ignition to the off position for 60 seconds after changing the switches!**

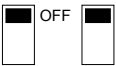
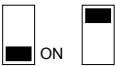
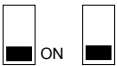

DIP switch settings for BMW/Mini

The following DIP switch settings are used to configure the Silverline DUO module to interface with the various vehicle radios. Before installation, set the DIP switch to the position shown for the corresponding radios.

Car configuration switches			
BMW Business CD Radio	BMW Navigation Radio	MINI with Navigation	BMW MID Radio
			
Recommended for single line display or non-navigation radio system. (Mini, 3-series, Z3, Z4, X3)	For 16:9 (wide screen) navigation radio system.	For 4:9 (small screen) navigation* and MINI Cooper with Navigation.	For non-navigation radio system on BMW 5, 7, X5 series MID units.

*4:9 (small screen) navigation radios require special firmware available from DICE Electronics support.

Supported iPod models and firmware version requirements

Model	Firmware / OS Version
1G nano	1.3.1
iPod 5G	1.3
2G nano	1.1.3
iPod classic	1.1.2
3G nano	1.1.3
iPod touch	iOS 3.1.3
iPhone	iOS 3.1.3
iPhone 3G	iOS 4.2.1
4G nano	1.0.4
120 GB classic	2.0.1
2G touch	iOS 4.3
iPhone 3GS	iOS 4.3

Model	Firmware / OS Version
160 GB classic	2.0.4
5G nano	1.0.2
3G touch	iOS 4.3
iPhone 4	iOS 4.3
4G touch	iOS 4.3
6G nano	1.0

Attention installer! Please read the following!

DICE Electronics strongly recommends that the unit be installed in an easily accessible place!

DO NOT PLACE IT BEHIND THE RADIO!

Whether the unit is professionally or self installed, put the module where you, the end user can get to it easily in the future. (Have the installer show you where the DICE interface module is installed.)

Installing the DICE module behind the radio will make it difficult to:

- Add possible future upgrades, changing software, adding new features, improving operation;
- Access the AUX input on the module to attach any audio device;
- Access the DIP switches located on the module;
- Remove the unit in case of failure.

MAKE SURE THAT THE MODULE IS IN AN ACCESSIBLE PLACE!

Connection diagram

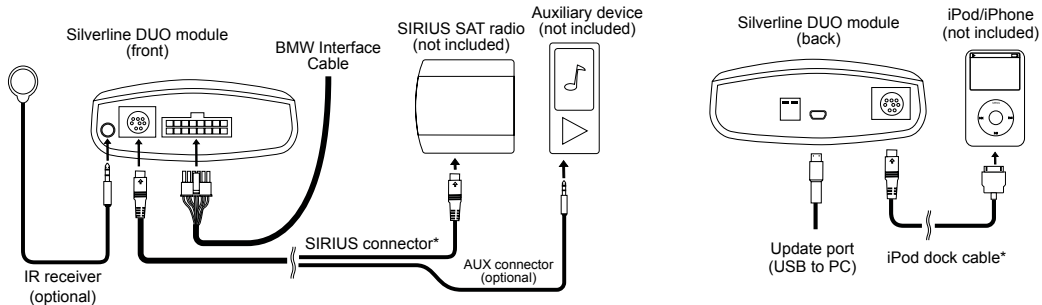

* Do not connect the iPod dock cable under any circumstance to the SIRIUS module connector! Improper connection can cause permanent damage to iPod/SIRIUS module.

Connection diagram for DSP option

BMW vehicles with Digital Signal Processing (DSP) must use the DICE DSP Kit (PN: ACC-BMW-DSP). To confirm if the vehicle has DSP, check for a bare metal coax cable and a 3-pin connector (for connector locations see page 13). DSP was only an option on **some BMW 5-Series, 7-Series, X5, Z4 and X3 vehicles.**

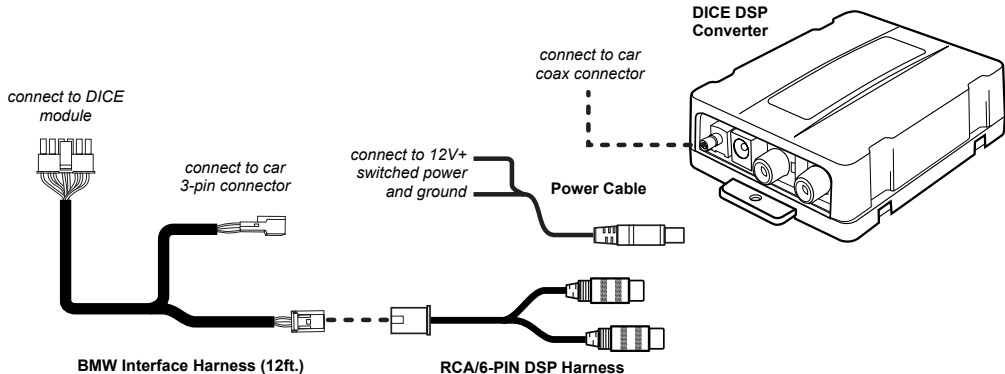

Factory pre-wired CD changer cable locations

○ DSP Amp

✕ 3-pin/6-pin (or coax) connector location



Mini

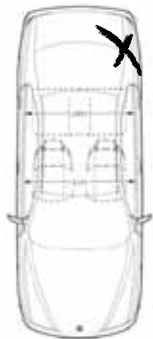

3-Series and Z3

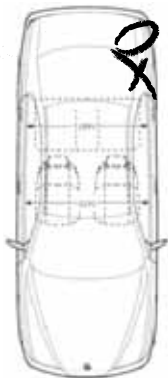

5-Series, 7-Series and X5



Z4

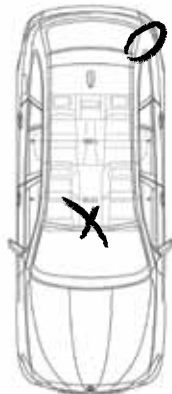

X3

Installation

Note: Installation should only be performed by a qualified professional. Beware of sharp edges to avoid injury and exercise caution when removing trim pieces as they may break. The module should be placed in an accessible location, such as the glove box, consoles, under the front seats or in some cases in the trunk to allow iPod/SIRIUS/AUX cables to be connected. The module firmware may need to be updated periodically and must be removed from the vehicle and connected to a computer to apply the update.

1. Disconnect both battery terminals. These cables must be disconnected during installation to ensure proper initialization of the DICE module when it is connected. **This step is REQUIRED for proper operation of the DICE module!**
2. Access the CD changer cable. The location of this cable varies by BMW model (for connector locations see page 13).
3. **If the vehicle you are performing the installation on has DSP, refer to page 12 and then proceed to step 5.** Locate both the 3-pin & 6-pin connectors. If the vehicle has a factory CD changer installed, the 3-pin & 6-pin cables will be connected to it and will need to be disconnected. If there is not a CD changer installed the cables will be bundled and may be tucked away behind carpeting.



Some vehicles will have the CD changer wiring in a protective sheath which may make it more difficult to locate. **Non-US models** may not be pre-wired for a CD changer, and require an additional harness from BMW to be connected.

4. Connect both 3-pin and 6-pin cables to the DICE BMW Interface Harness.



ATTENTION! There are two 3-pin connectors presented in the vehicle. During installation, make sure that the 3-pin connector from the vehicle **DOES NOT** have a brown wire in the middle! The 3-pin connector of the phone pre-wiring looks identical to the 3-pin connector of the CD changer pre-wiring. Locate and use the correct 3-pin cable with the brown wire on the outside! Incorrect connection will result in permanent damage to the unit and will not be covered by warranty!

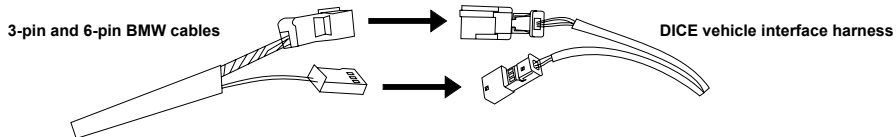

5. Route the interface cable to the front of the vehicle. Fold down rear seats (if applicable) and route the extension cable through the rear seat bottom cushion. Route the remainder of the interface cable (*ie.* under the door sill or under the driver's seat) to a location where the module can be easily accessed in the future.
6. Make sure you have set the DIP switches on the DUO as specified on page 8.
7. Connect the BMW interface cable, iPod Dock Cable and SIRIUS Connections (if applicable) to the DUO module and double-check all connections. See page 11 (and page 12 if the vehicle has DSP) for the connection diagram.
8. Test the installation.
9. Replace any trim, carpeting or panels that were removed during installation.

iPod content heirarchy

By default, the interface creates a Playlist having a name that is the same as the name of the iPod. This Playlist is the very first on the list of Playlists shown while browsing in Playlist mode. This Playlist contains all the songs on the iPod. Once a Playlist is selected an Artist may be selected within that Playlist using the Artist Mode. Albums by the selected Artist within the selected Playlist may be selected in Album Mode. "ALL ARTIST" and "ALL ALBUM" designate all available content in those categories.



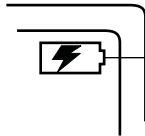

Charging

The interface automatically charges the battery of the iPod when connected and your vehicle ignition key is in the ACC/ON position.



Charging may be shown by an icon that appears on the upper right corner of the iPod screen. May vary by model.

iPod locked/unlocked settings and features

	iPod hold ON	iPod hold OFF
		
Radio control	✓	Limited
iPod control	✗	✓
	Before connecting the iPod to the DICE module, turn the hold switch ON to fully control and browse the songs from the wireless remote. The iPod is locked in this state.	Before connecting the iPod to the DICE module, turn the hold switch OFF to fully control and browse the songs from iPod. Browsing capabilities are limited from the wireless remote.

Note: Setting the iPod's hold switch must be done prior to connecting it to the dock cable.
 iPod nano 6th generation will always be in locked mode since it does not have a lock switch.

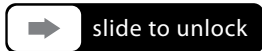

For iPod touch and iPhone, when the screen is not active (as shown on the left), the iPod/iPhone is locked (Press the power button to lock the iPhone/iPod Touch).

Basic operation

Accessing the DUO as the audio source:

Much like the radio's AM/FM tuner, satellite radio or CD audio sources, the Silverline DUO is integrated to be part of the vehicle's audio system. To access the DUO source, press the MODE or CD button on the radio. Pressing this button repeatedly will cycle through sources present in the vehicle (CD > DUO).

DUO source selection:

The DUO adds additional audio sources including iPod, SIRIUS Satellite Radio* and auxilliary audio input*. To cycle between these sources, use the next/previous TRACK buttons within the first 5 seconds of accessing the DUO as the audio source.

**These sources require additional parts/accessories/service from DICE and/or third parties.*

Silverline DUO Interface settings (within first 5 seconds of accessing the DUO as the audio source):

Select DISC 2 to set iPod charging time AFTER car's ignition is turned OFF.

Select DISC 3 to change gain setting.

Select DISC 4 to enable/disable scrolling text.

DISC 5 - no settings are assigned to this button.

Select DISC 6 to view Silverline DUO firmware version.

Select DISC 1 to apply settings and resume audio playback.

Controlling the DUO from select BMW and Mini radios

Illustration showing BMW Business CD Radio

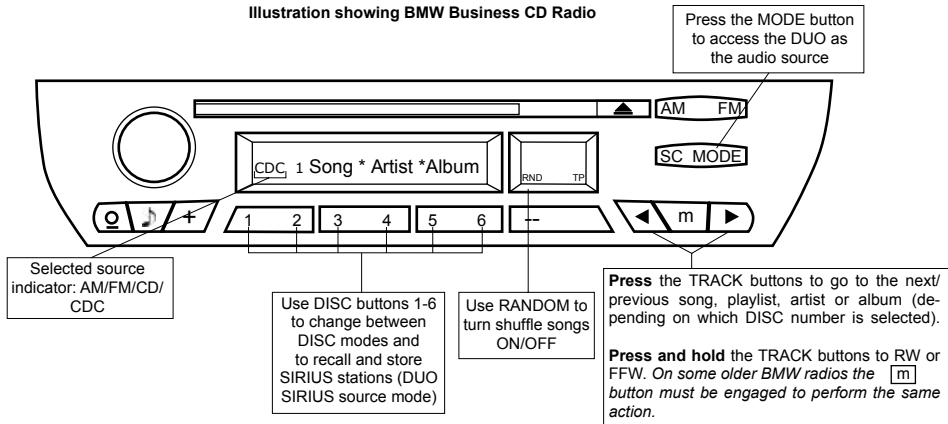

Illustration showing BMW 16:9 Navigation radio

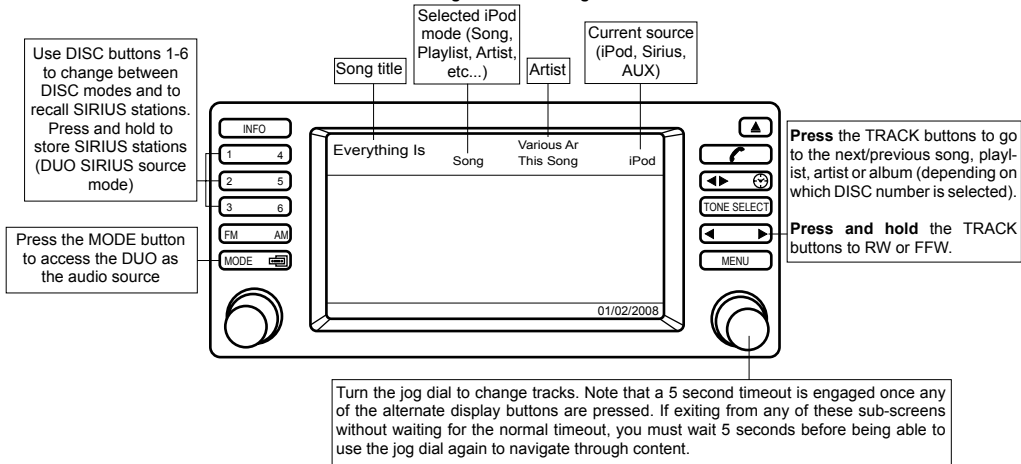

Illustration showing Mini Navigation radio

Song/Artist/Playlist displayed here

Press the MODE button to access the DUO as the audio source

Press the TRACK buttons to go to the next/previous song, playlist, artist or album (depending on which DISC number is selected).

Press and hold the TRACK buttons to RW or FFW. *On some older BMW radios the **m** button must be engaged to perform the same action.*

Selected source indicator: AM/FM/CD/CDC

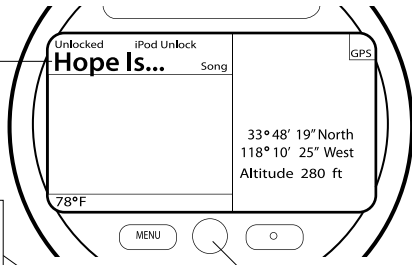

Turn DIAL for next/previous track.

Press DIAL to store SIRIUS station presets (DUO SIRIUS source mode; see page 24).

On Mini navigation radios, the RND button is used to toggle between **Menu** and **Text** modes.

Text Mode (RND enabled): Displays text from the DUO such as Song/Artist/Playlist titles.

Menu Mode (RND disabled): Displays the default navigation and vehicle menu screens.

Use DISC buttons 1-6 to change between DISC modes and to recall and store SIRIUS stations (DUO SIRIUS source mode).

Used to store stations to Presets 1-5.

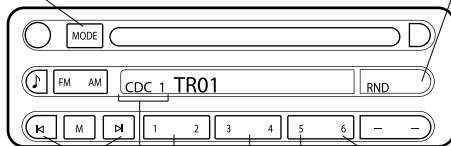

Controlling the DUO iPod source

The Silverline DUO integration kit features content browsing. After connecting the iPod, select the desired browsing mode by selecting the appropriate DISC. Press the SEEK button or turn the TUNE dial repeatedly to browse contents. 1 second after releasing the button, your selection is executed. The browsing function below is illustrated in the “Track” field.

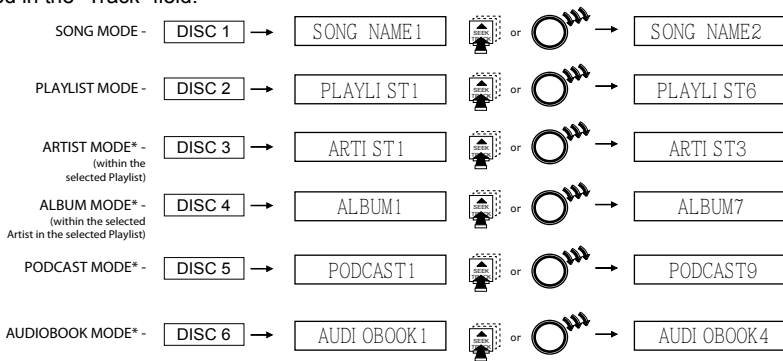

*Only available when iPod is locked. When iPod is unlocked the radio will only display song titles.

Controlling the DUO SIRIUS source

The Silverline DUO integration kit features SIRIUS connectivity. Use the TRACK buttons or jog DIAL to browse between subscribed channels.

To store a subscribed channel to memory:

- **Single line radio:** Tune to desired station. Press RANDOM button and select which DISC button (preset 1-6) to save to. Press RANDOM button once more to store the station.
- **Navigation radios:** Tune to desired station. Press and hold the desired DISC button (preset 1-6) to save as preset.
- **Mini navigation radio:** Tune to desired station. Press jog DIAL, press desired DISC button (1-6), press DIAL to save.

To recall a memorized channel: Simply press the desired DISC (preset 1-6).

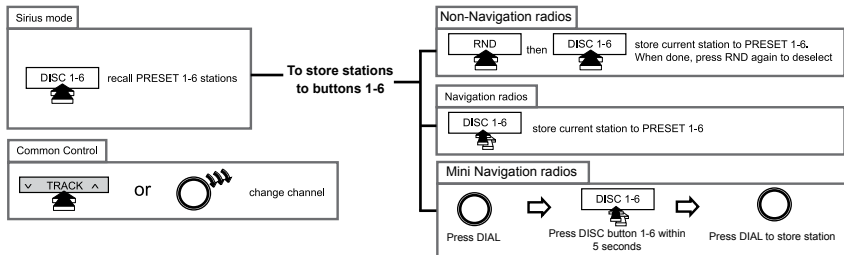

NOTES: If a SIRIUS CONNECT compatible tuner is not detected, then a "No Tuner" vehicle message is displayed.

Go to Channel 000 to view the SIRIUS Tuner ID for activation. The 12 digit SID display format is shown in two parts as SID "123456-" followed by "-789ABC".

The Livio Car Internet Radio application (iPhone/iPod touch)

This DICE integration kit includes support for the Livio Car Internet Radio application. It's available on the iTunes® Store, try the FREE app and listen to hundreds of Internet-based radio programming options streamed through the 3G/ Edge or Wi-Fi connection. Download the upgraded Livio Car Internet Radio application for a fee to stream more than 45,000 AM/ FM and Internet-only radio streams from around the world.

Help is available for the Livio Radio application by calling **1-877-97-LIVIO** or going on the web to **<http://support.livioradio.com>**. You can also visit **<http://www.livioradio.com/iphonocarhelp>**. If you do not have version 2.2.0 or newer of the Livio Car Internet Radio application, please visit the App Store to download it for free.

Data connection requirements (3G/4G/WiFi)

Users must have an active wireless data connection in order to stream music from the Car Internet radio App while driving. Data connections including "3G" or "4G" through wireless carriers, or a third party wireless Internet access point connected to your mobile device thru WiFi will work. Because this app requires a data connection, it will only work on the iPhone and iPod touch.



Controlling the Livio Car Internet Radio app

The app must be active on the screen of the iPhone or iPod touch. To do so, users can simply tap the Livio icon on their device and it will load. For example, users can tap on the text area of the app to stop or play the selected stream. For additional details or further support, please visit <http://www.livioradio.com/car/>.

Next/previous TRACK buttons cycle between Livio station presets.
DISC (1-6) buttons will select one of the first six Livio station presets.

iPhone 4, iPhone 3GS, iPod touch 4th and iPod touch 3rd generation devices with iOS 4 (4.3.3) offer limited basic control when an app is running in the background. Text, advisory messages or direct preset tunes therefore are not available. Message on the radio shows "LIVIO (background)" when the app is running in the background.

Please note that although iOS 4 (4.2.1) is supported on iPhone 3 and iPod touch 2nd generation, applications do not run in the background. As such, loading the Livio application takes longer than on devices where the app is present in the background.



If your listening experience is interrupted by a call, under most conditions, the application will resume playback at the end of the call.

Music playback applications running on your iPhone are sent to background automatically when the home button of the phone is pressed, but the music playback itself is not stopped.

To resume playback of your iPod music library, stop Livio playback by tapping on the screen below the Livio Radio logo. An icon representing “stop” will show on the main Livio screen. Press the home button to send the application to the background.

A few seconds after this, the iPod music playback application will reinitialize itself and become active again if the iPod was locked when it was connected to the DICE kit. (This is indicated by an Accessory Connected message being shown when the iPod icon is tapped.)

If the iPod was in unlocked state when it was connected to the DICE kit, press the play button on the iPod application.

Text display from the Livio Car Internet Radio app

Text that scrolls across the radio’s screen is associated with the stream shown on the radio and displays current song or station information.

Terminate (kill) the Livio Car Internet Radio app

If you need to terminate (kill) the Livio application please follow the steps below:

1. Double-tap on the home button of the iPhone to bring up the list of running applications. If you don't see the Livio Car Internet Radio icon right away, swipe the screen left or right to locate it. Note: If you do not see such task bar but rather a music control popup then you have an iOS device that does not support background run of applications, therefore this section is not applicable to you.
2. Press and hold the icon of the application until a red minus icon shows.
3. Tap the red minus icon shown on top of the Livio Car Internet Radio icon.
4. This will close the application.
5. In a few seconds, the iPod music playback application should reinitialize itself and become active again. This can be verified by going back to the list of running applications and swiping the screen until the music control section is shown. The iPod application icon next to the music control sections shows that iPod is your audio source.

Livio Car Internet Radio app settings

Many radio stations offer lower bitrates. Selecting streams with a lower bitrate will reduce data usage and may reduce stream interruptions during the drive. To adjust bitrates automatically, users can:

Go to the Setting menu of the device, select the Livio Radio settings the change the Maximum Bitrate Filter and set it to 64K. Other settings such as Buffer time and Reliability filter may also help in getting a more stable connection.

Optional Remote Kit: Functions for iPod/Livio Internet Radio app

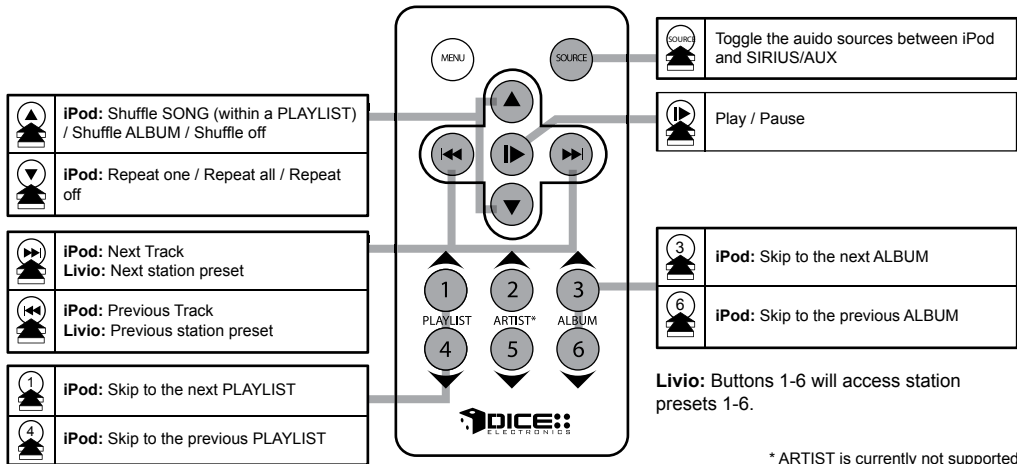

Optional Remote Kit: Functions for SIRIUS

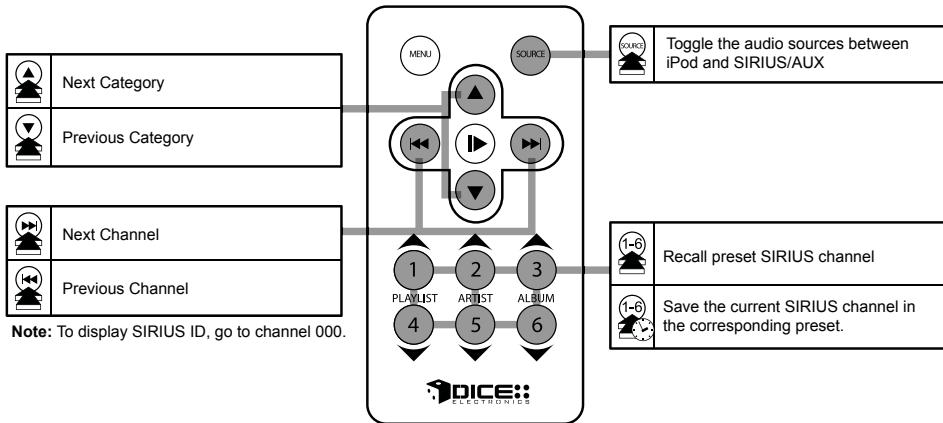

Troubleshooting

Problem	Solution
Radio/NAV display only shows DISC and track number and there is no iPod control.	Make sure DIP switch settings are correctly set for text display (refer to page 8 for DIP switch settings).
No text display on radio.	Make sure DIP switch settings are correctly set for text display (refer to page 8 for DIP switch settings).
Correct DIP switch settings but still no text display.	Select DISC 6 to set text output to the correct location (refer to page 19).
Radio/steering wheel controls do not operate iPod.	Reset iPod and make sure most recent iPod firmware is installed.
Music is distorted or sound level is too low with iPod connected.	Make sure all EQ and BASS boost options are turned off on your iPod. Adjustments to the gain setting may be required (refer to page 19).
No audio from iPod source.	Reset the iPod. Verify proper connection to iPod/interface. Check for compatibility. Older iPod models don't support USB audio.

Problem	Solution
Sirius tuner can't be selected.	Ensure the cable connecting SIRIUS tuner is securely connected to the correct receptacle.
Why does the radio display show "EMPTY/STOP" and no music plays?	The iPod has reached the end of a playlist. Please select a new Playlist.
Cannot select the interface.	Ensure the cable connecting SIRIUS tuner is securely connected to the correct receptacle. Verify that the correct button is used to access the interface.
Radio/ steering wheel controls do not operate iPod.	Reset iPod and make sure the most recent iPod firmware is installed. Check vehicle user manual on how steering wheel controls work, long presses may toggle alternate function.
Why does category read "PRESELCTD"?	Playback of content selected on the iPod before it is connected to the interface continues until new content is selected.

Problem	Solution
Why does the message “iPod UNLOCKED” display on screen?	When the Silverline DUO is playing iPod music in UNLOCKED mode, browsing mode information isn't available so the “iPod UNLOCKED” notification is shown. To view information associated with browsing modes, ensure the iPod's hold button is set before connecting it to Silverline DUO.

Firmware update

STEP 1: Disconnect the Silverline DUO module from the vehicle.

STEP 2: Download and install necessary software from www.diceelectronics.com

STEP 3: Open software to follow instructions for updating Silverline DUO unit.

STEP 4: Plug in Silverline DUO via mini USB cable and update.

STEP 5: Disconnect and reinstall the unit into the vehicle.

Silverline DUO module
(back)

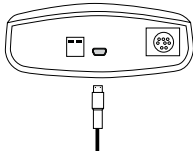

Mini USB port for software update

Disclaimer & Warranty

Important disclaimer, please read!

Unauthorized reproduction or reverse engineering is strictly prohibited! Intellectual property included is distributed under specific license agreement with respective owners and is licensed only, not sold. No warranty, explicit or implied, is stated. Neither DICE Electronics, LLC., nor any of its agents, distributors, dealers or vendors shall be liable for damages.

IN NO EVENT SHALL DICE ELECTRONICS' LIABILITY EXCEED THE PRICE PAID FOR THE PRODUCT FROM DIRECT, INDIRECT, SPECIAL, INCIDENTAL, OR CONSEQUENTIAL DAMAGES RESULTING FROM THE USE OF THE PRODUCT, ITS ACCOMPANYING SOFTWARE OR ITS DOCUMENTATION.

Support and warranty!

If you experience any problems or need help, please contact you local dealer or call DICE Electronics, LLC. At 888-342-3999 or visit us at <http://diceelectronics.com/product-support>

Products carry a 1 year limited warranty that protects you from defects in material and workmanship of products sold by DICE Electronics or its authorized agents, distributors and dealers. The warranty period begins the day a product is purchased by the end user. Products found to be defective during the warranty period will either be repaired or replaced by DICE Electronics at no charge unless warranty is void. Unauthorized attempt of repair or alteration of the product in any way immediately voids this warranty.

Warranty does not extend to cosmetics or finish. A DICE product specialist must determine that a defect is present in the product and issue an RMA. Be sure that all wiring is connected as described in the user manual and all related equipment is functioning properly. DICE Electronics disclaims any liability for other incurred damages resulting from product defects. Any expenses in the removal and reinstallation of products are not covered by this warranty.

PLEASE NOTE: International customers requiring a product replacement, please contact the dealer your product was purchased from!

Installation notes:

Installed by:

Installed date:

Other notes:

Illustration:

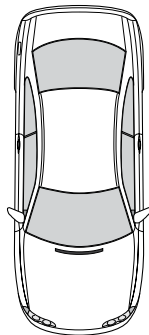



**BMW/Mini compatible integration
for iPod, iPhone, Internet Radio and SIRIUS.
www.diceelectronics.com**

DUO-BMW-071211